

# EXPERIENCE THE MISCEA AQUAMORE SYSTEM

## ENJOY WATER DIRECT FROM YOUR FAUCET LIKE NEVER BEFORE

Like magic, the new miscea aquamore System will give you pure, fresh, still, sparkling, and flavoured water with a simple wave of your hand. It is the first completely touch free and hygienic sparkling water faucet system of its kind that features miscea aqualibur Technology to safeguard drinking water against bacterial contamination.

Made from 100% medical grade stainless steel, the sleek contemporary faucet design of the miscea aquamore faucet makes it a stylish addition to any kitchen, bar, entertainment area or semi-public establishments. Experience the healthy, safe and environmentally friendly alternative to bottled water with the new miscea aquamore range.

The miscea aquamore System is available in the following two variants:

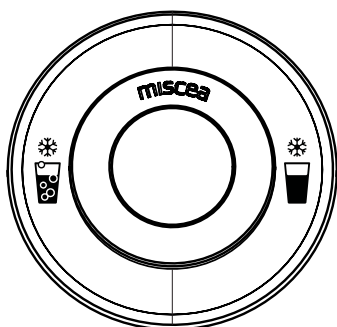

### MISCEA AQUAMORE DUO

The miscea aquamore Duo System has two chilled and filtered beverage options:

- still water
- sparkling water

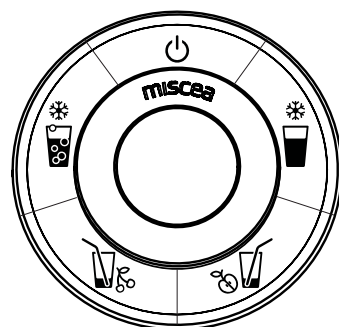

### MISCEA AQUAMORE QUATTRO

The miscea aquamore Quattro System has four chilled and filtered beverage options:

- still water
- sparkling water
- up to 2 syrup flavours





## PRODUCT INFORMATION: MISCEA AQUAMORE SYSTEM

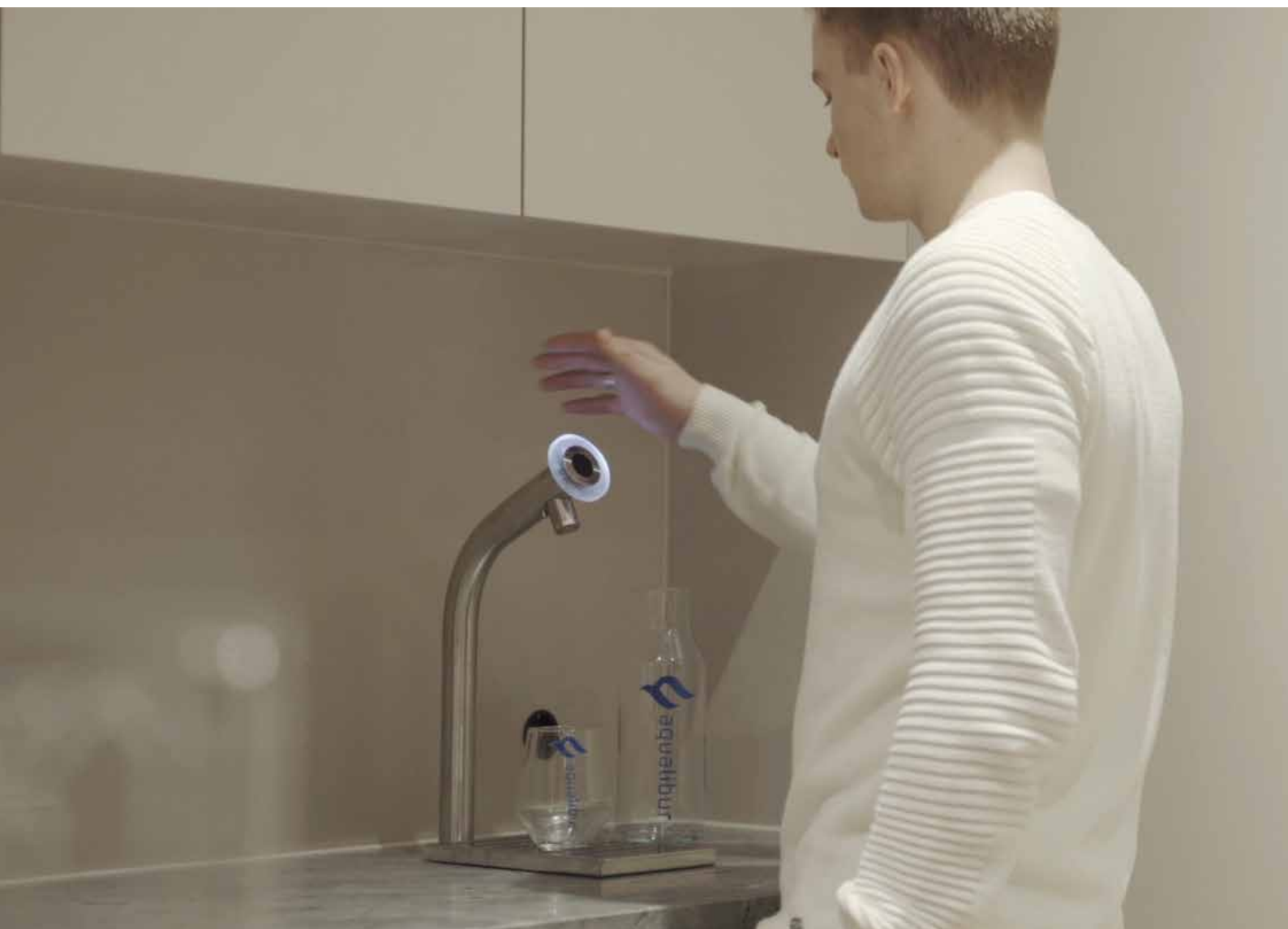

### TRULY HYGIENIC, CONTACTLESS SPARKLING WATER.

The miscea aquamore System is the first truly contactless, hygienic, and possibly the most elegantly designed sparkling water faucet on the market. Whether at home, the office or in any commercial setting such as a hotel, restaurant, or hospital, the abundance of high-touch surfaces and objects make it easy for people to inadvertently transmit illness-causing pathogens from one surface to another. Enjoy proper hydration with the miscea aquamore System for reliable, instant, and completely touch free access to clean, great tasting, still, sparkling, and flavoured water options.

### ENJOY COST SAVINGS WITH MISCEA AQUAMORE.

Using miscea aquamore Systems means several costs associated with using bottled water systems can all be avoided, including high purchasing costs as well as transport, storage, maintenance, and disposal costs.

### ENJOY ENDLESS HYDRATION WITH MINIMAL EFFORT.

Using bottled water systems means on-site storage space for full and used bottles is required. Depending on the services offered, there must always be someone on site for scheduled pick-ups or deliveries.

The miscea aquamore System eliminates the need for any on-site storage. The entire system is compact, fits underneath the sink cabinet and designed to ensure an endless supply of great tasting drinking water direct from the faucet.



**ENJOY SAFE AND HEALTHY WATER SUSTAINABLY.**

The life cycle of a water bottle from beginning to end, requires a range of manufacturing, distribution, and disposal processes. During each of these stages, harmful greenhouse gases are released into the environment as large amounts of scarce resources are used to create, store, and transport the bottles. In short, the use of bottled water is environmentally damaging, wasteful, and simply unsustainable.

The miscea aquamore System connects directly to your building's water source and filters the water at the point of use for safe, clean, and healthy water. This reduces not only the waste created from using bottled water but also the production and distribution pollution associated with bottled water.

**THE LIFE CYCLE OF A PLASTIC BOTTLE**

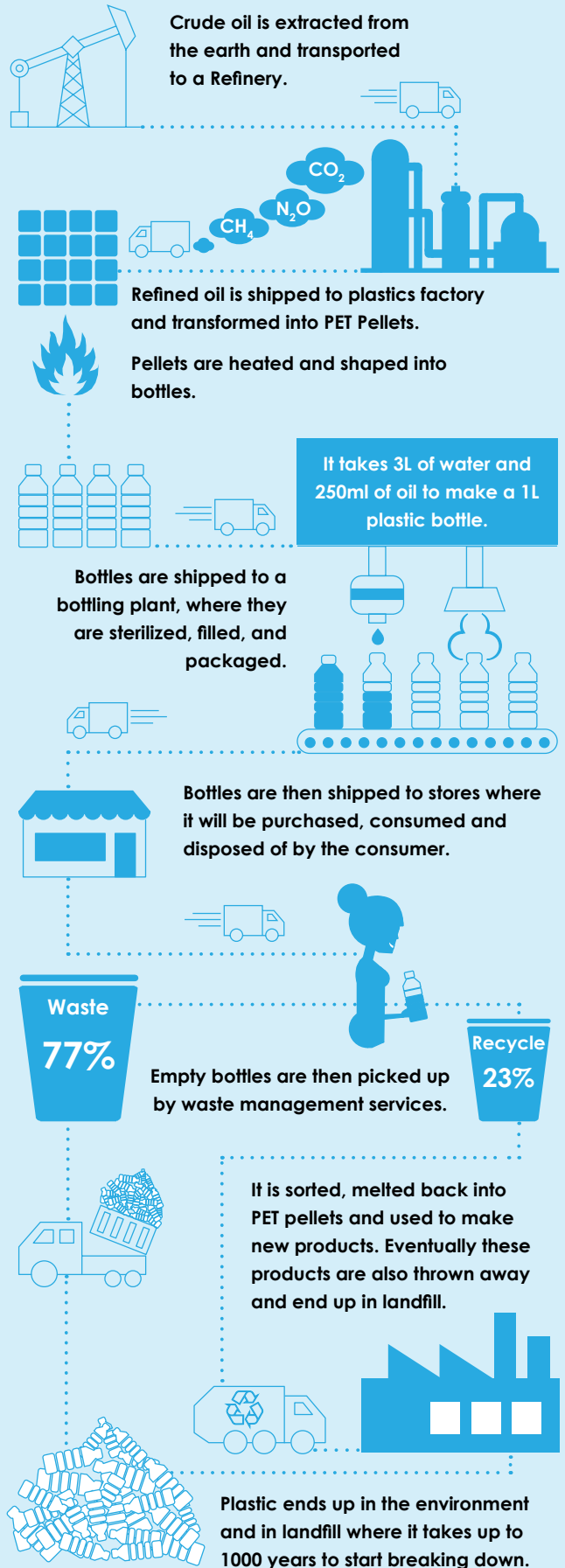

# PRODUCT INFORMATION: MISCEA AQUAMORE SYSTEM



## SELF CLEANING SYSTEM WITH INTELLIGENT WATER HYGIENE TECHNOLOGY FOR CLEAN, PURE, HEALTHY WATER

The miscea aquamore System not only reduces the potential for cross contamination through the use of advanced sensor technology, it also features a number of smart water hygiene technologies that help to keep the system fresher and cleaner for longer.

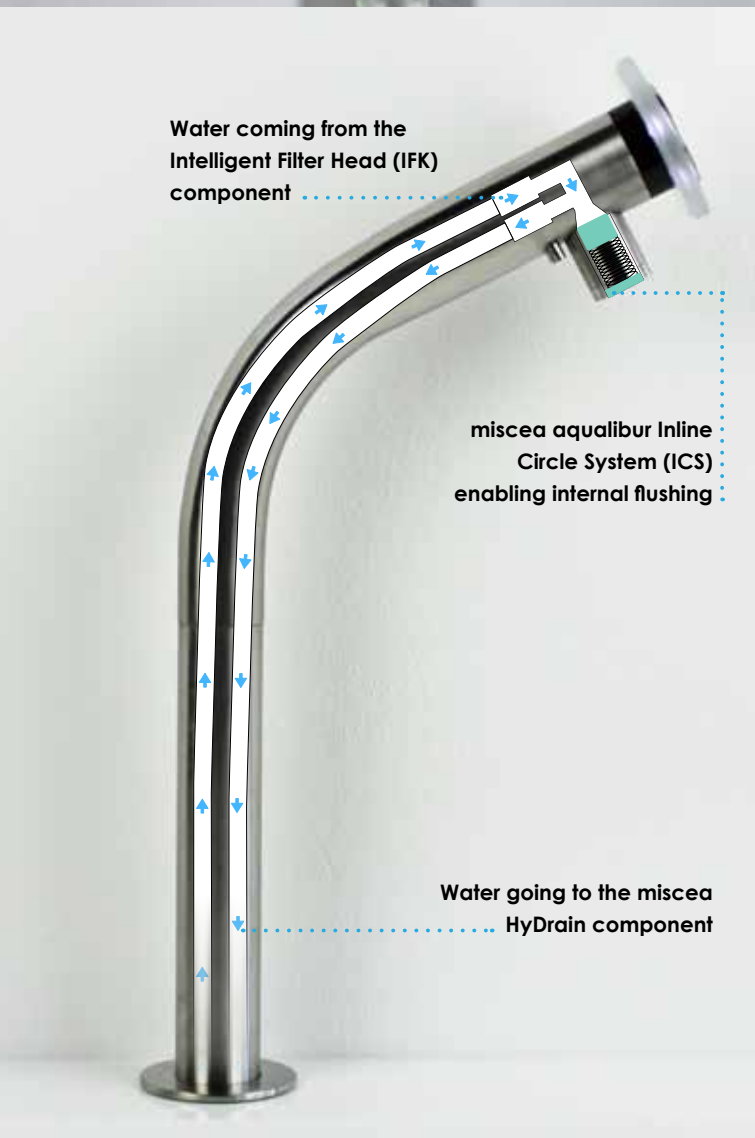

## + MISCEA AQUALIBUR WATER HYGIENE TECHNOLOGY

miscea aqualibur Water Hygiene Technology is the result of the successful collaboration between miscea GmbH and Waterhouse ATT – two companies with over 40 years' combined experience in the sanitary industry on water hygiene and safety.

This state-of-the-art technology uses the patented Intelligent Filter Head (IFK), the Inline Circle System (ICS) and the miscea HyDrain to efficiently keep the internal components of water faucets clean, hygienic, and prevent waterborne contaminations caused by stagnant water.

These core components together enable safe and automatic internal flush cycles, and when required, also chemical disinfection of the waterline to occur without disturbing the immediate surrounding.

***Enjoy completely automatic internal flush cycles for contamination free water.***

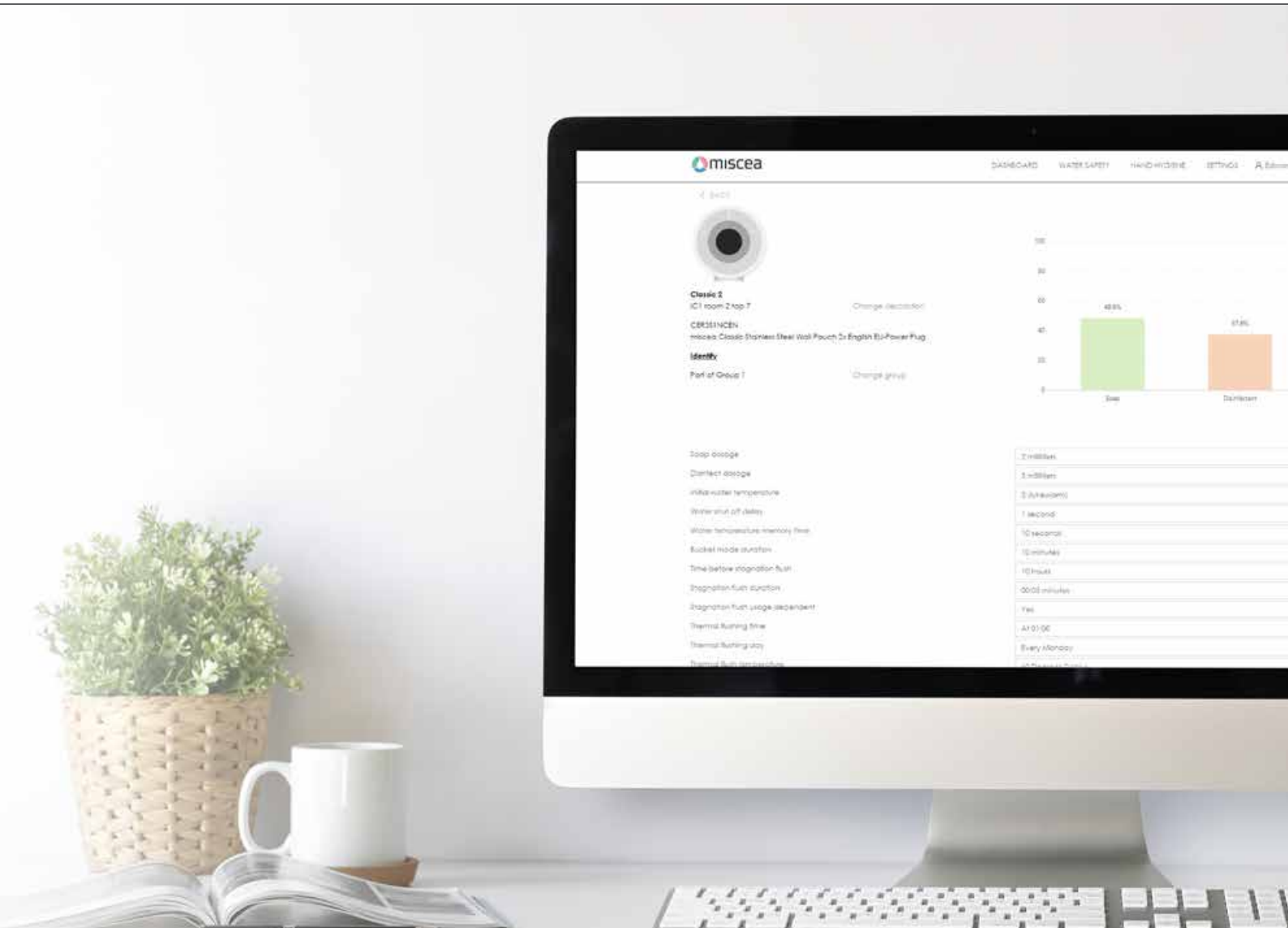

**+ ANTIBACTERIAL AERATOR**

This special aerator has antibacterial properties to protect the water outlet from contamination. It only needs to be changed once every 5 years.

**+ WATER FILTER**

Leaving behind only essential salts and electrolytes for safe, healthy, and great tasting water, the miscea aqualibur Water Filter is cost-effective, filters 100% of water used, and removes 99,99% of various water impurities.

**+ CENTRALIZED MANAGEMENT**

Optionally available for management and configuration of all faucets fitted with miscea aqualibur Technology is the miscea aqualibur Web Based Application – an easy to use online platform that collects data through a Wi-Fi connection, from every faucet using miscea aqualibur Technology on the premises.

Enquire at [info@miscea.com](mailto:info@miscea.com) for more information.

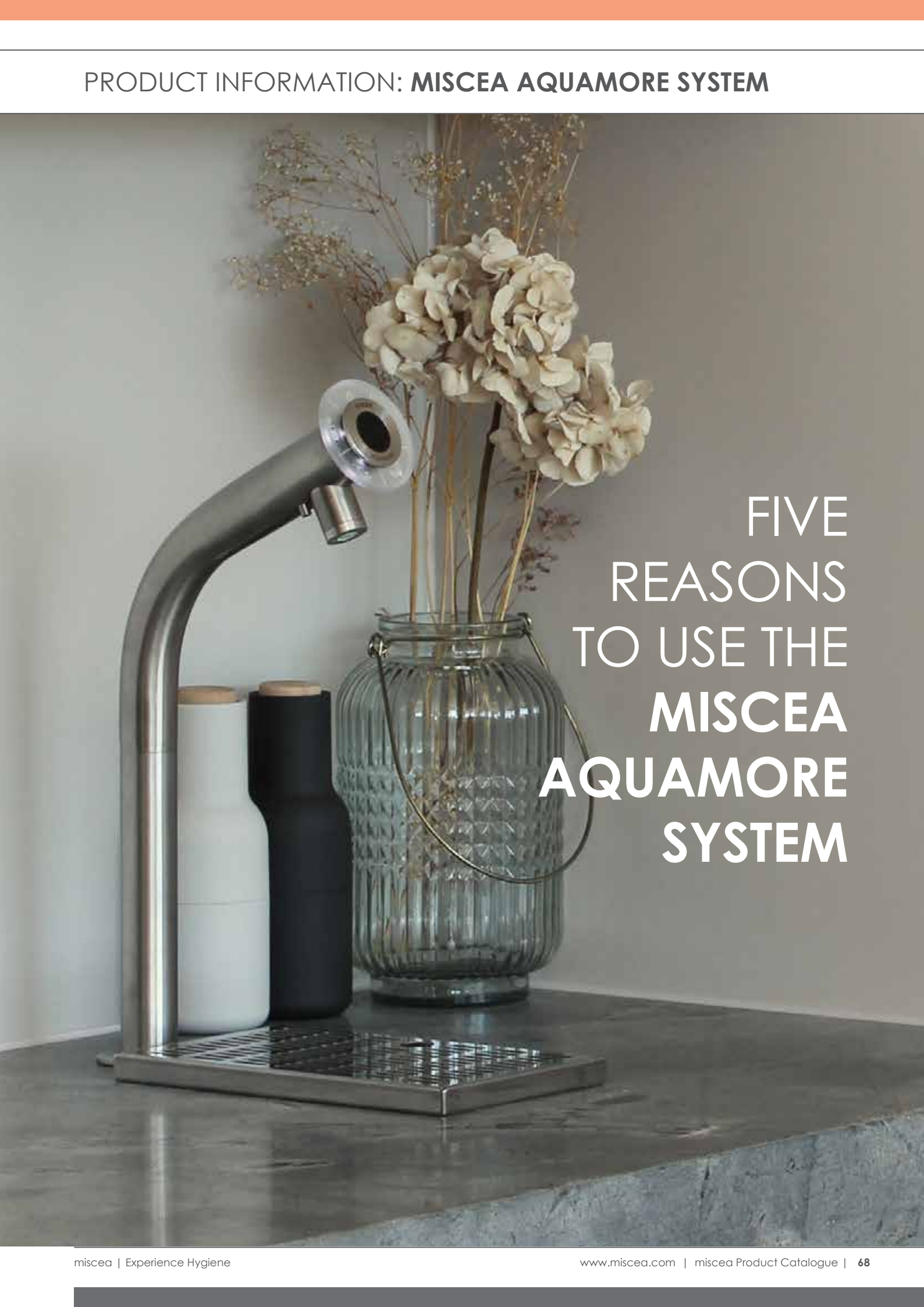
A modern, minimalist coffee machine with a curved stainless steel frame and a glass carafe. The machine is placed on a dark, textured surface. To its right is a clear glass vase with a metal handle, containing dried white flowers and greenery. The background is a plain, light-colored wall.

FIVE  
REASONS  
TO USE THE  
**MISCEA**  
**AQUAMORE**  
SYSTEM

**1****EXPERIENCE THE TRULY HYGIENIC DRINKING WATER SYSTEM**

Hygienically access instant, fresh, filtered water with the completely contactless miscea aquamore sensor faucet system.

**2****ENJOY FRESHLY FILTERED WATER SUSTAINABLY**

Take a step forward towards a better and brighter future by avoiding the waste and pollution associated with bottled water.

**3****EASILY SAFEGUARD YOUR DRINKING WATER**

Effortlessly minimize the risk of microbial contamination in your drinking water through effective control of water stagnation with automated internal water hygiene flushing from miscea aqualibur Technology.

**4****REDUCE COSTS BY USING MISCEA AQUAMORE**

Eliminate unnecessary costs associated with bottled water and eliminate labour intensive water disinfection procedures.

**5****DISCOVER OUR RANGE OF AWARD WINNING FAUCET DESIGNS**

Experience clean and sleek sensor faucet designs from miscea to compliment any modern interior space.



# PRODUCT INFORMATION: MISCEA AQUAMORE



## FINISH OPTIONS:



Stainless steel

## SPECIFICATIONS

Please request technical specifications from miscea GmbH at [berlin@miscea.com](mailto:berlin@miscea.com)

## DESCRIPTION

Hygienic drinking water system for chilled filtered still and sparkling water with the option to include 2 integrated syrup dispensers for flavoured water.

## FEATURES

- Electronic faucet for still and sparkling water
- Faucet user interface made of high quality laser engraved glass
- Options include:
  - chilled filter still and sparkling water
  - 2 syrup flavour concentrate dispensers (only available with miscea aquamore Quattro model)
- Hygienic touch free controls of all functions
- miscea aqualibur Technology:
  - ICS - automatic internal flushing technology for prevention of water-borne bacteria. Cycles completely adjustable with the miscea remote control or miscea Web App (sold separately).
  - miscea HyDrain - prevents retrograde contamination of the system and overflow.
  - miscea aqualibur IFK and water filter
- Antibacterial Sterionuklide aerator

## INCLUDED

- miscea aquamore **Duo** / miscea aquamore **Quattro** faucet
- Waterbox
- Syrup Box (only for version Quattro)
- 2 x 1 L Syrup Concentrate Flavours (only for version Quattro)
- Stainless steel braided hoses for water connections (850 mm)
- miscea aqualibur Intelligent Filter Head (IFK)
- aqualibur Filter
- 425g CO2 Tank
- miscea aquamore Carbonator
- miscea Hydrain
- Power plug (Cable length 1800 mm)
- 1 x Installation kit, 1 x Instruction manual

All measurements in mm.

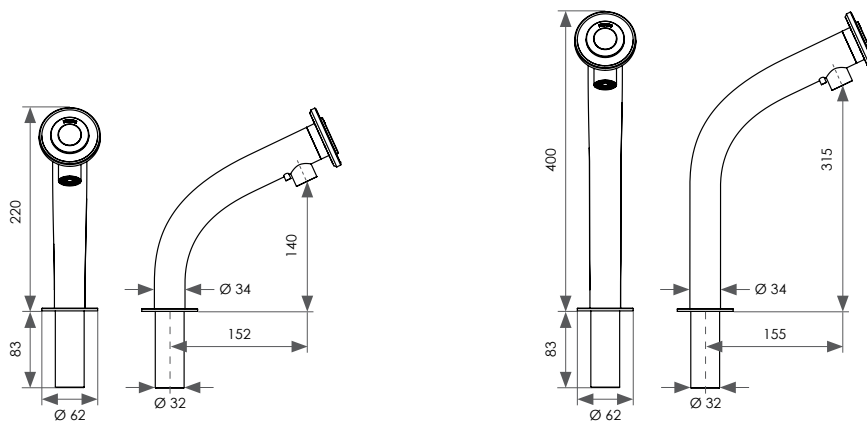

MODEL:

*miscea aquamore Standard*

*miscea aquamore Large*

# PRODUCT INFORMATION: MISCEA AQUAMORE

FINISH OPTIONS	MODEL		SYRUP BOX		DISPLAY		PRICE €	ART. NR.
	Standard	Large	No Syrup	Pouch	Duo	Quattro		
 Stainless Steel	✓		✓		✓		2.860,00	ADER1NC
	✓			✓		✓	3.195,00	AQER1S1NC
		✓	✓		✓		2.998,00	ADER5NC
		✓		✓		✓	3.349,00	AQER5S1NC

Prices are exclusive of VAT, and shipping costs

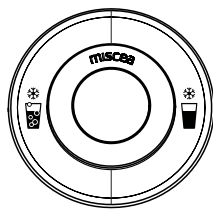

DUO

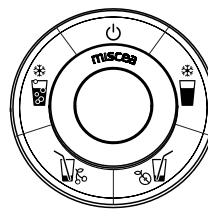

QUATTRO

DISPLAY:

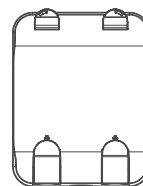

FOR POUCHES

SYRUP BOX (OPTIONAL):

CORE SYSTEM COMPONENTS:



WATERBOX



MISCEA HYDRAIN

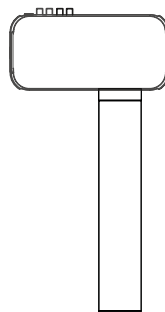

AQUALIBUR IFK + FILTER



CO2 TANK

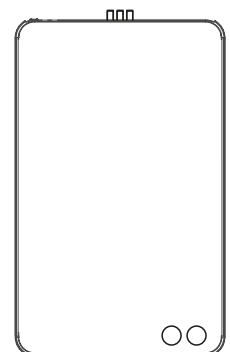

CARBONATOR